

20.30.1800.00

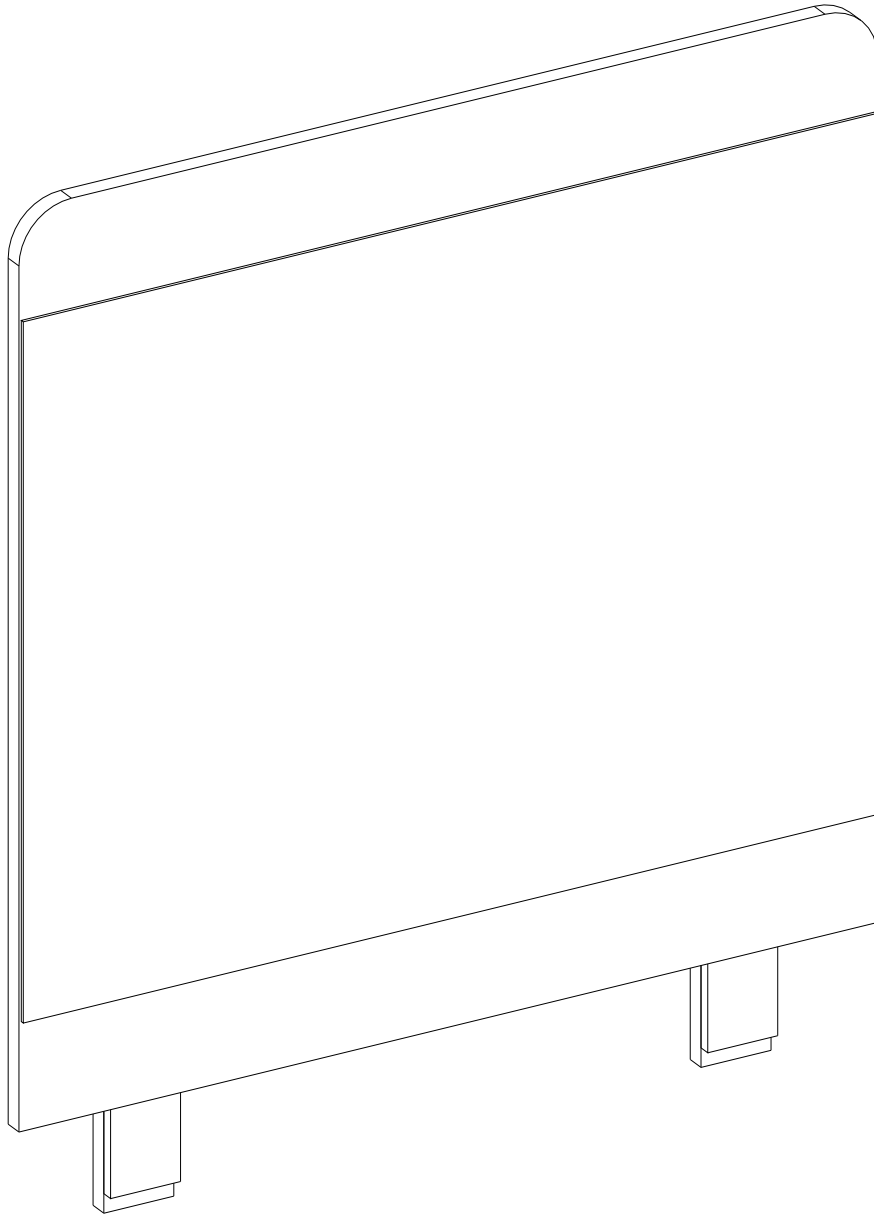

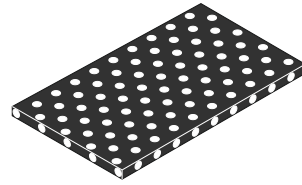

1 / 1

1 / 1

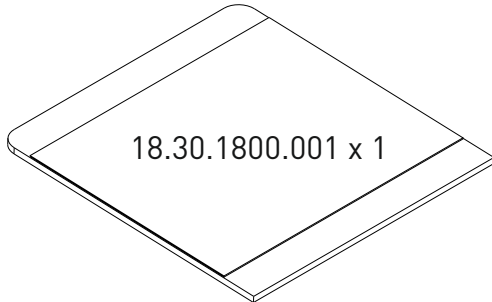

18.30.1800.001 x 1

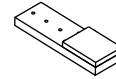

18.30.1800.002 x 2

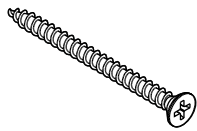

13.02.01.009 x 4
4x40

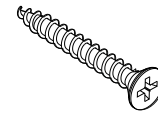

13.02.01.007 x 6
4x30

1

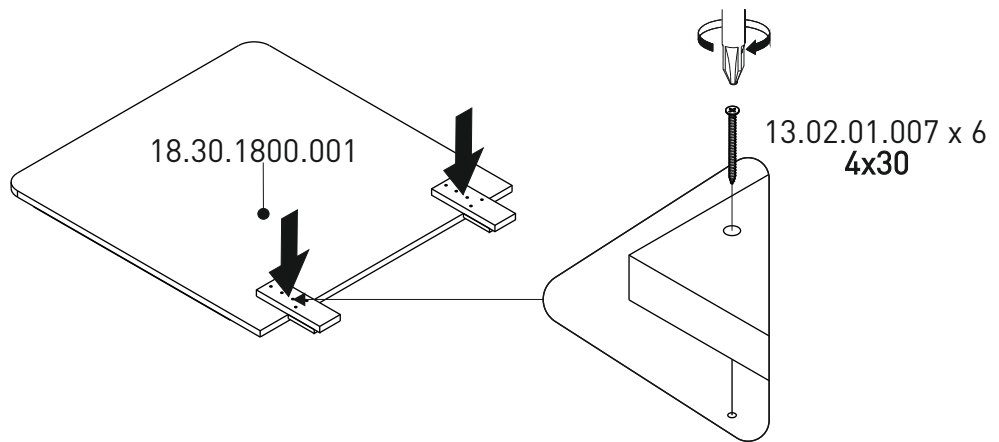

2

