

20.40.1302.00

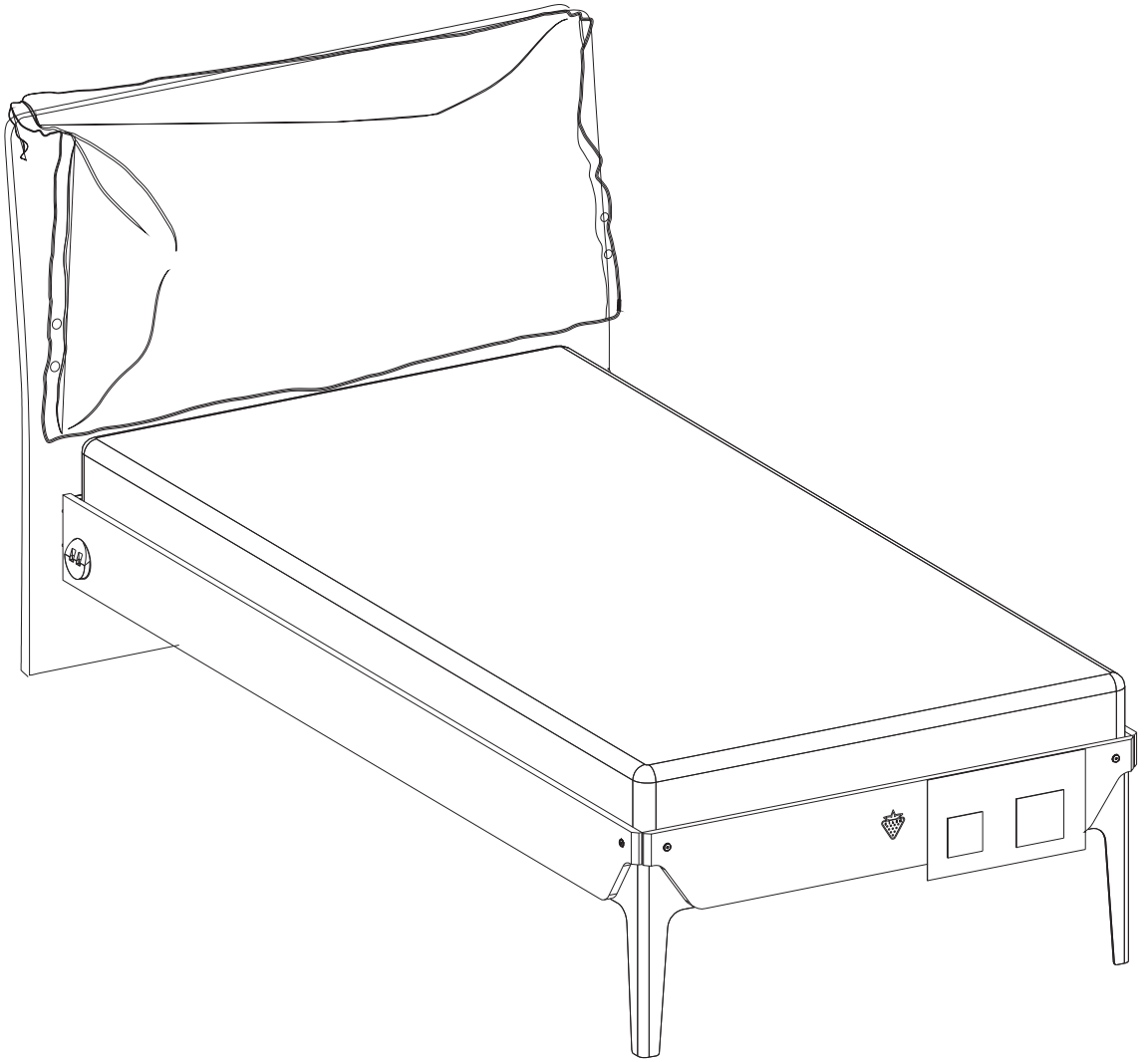

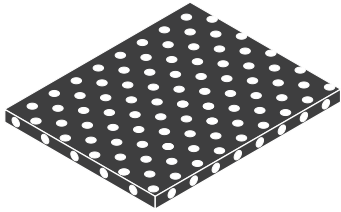

3 / 1

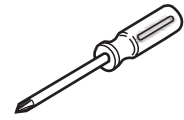
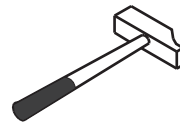
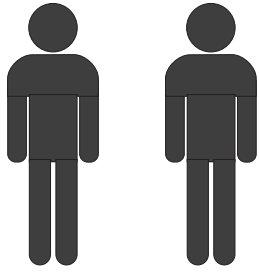

3 / 2



3 / 3

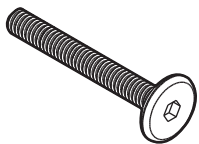

13.03.01.033 x 8

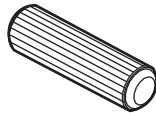

13.01.01.111 x 4



13.02.01.018 x 28



13.07.01.093 x 4



13.03.01.007 x 2

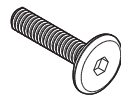

13.03.01.023 x 4

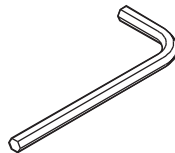

13.07.01.016 x 1

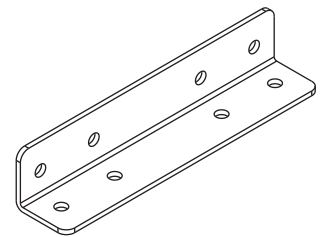

13.07.01.399 x 2



13.03.01.021 x 24

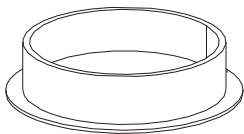

13.01.01.560 x 1

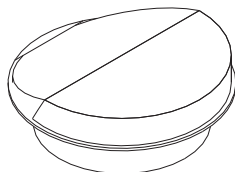

13.15.01.118 x 1

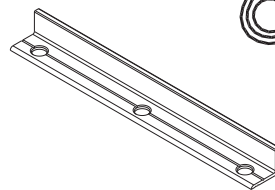

18.40.1302.203 x 2

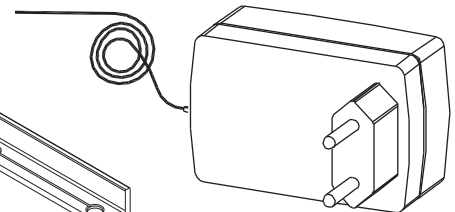

13.15.01.064 x 1

3 / 1

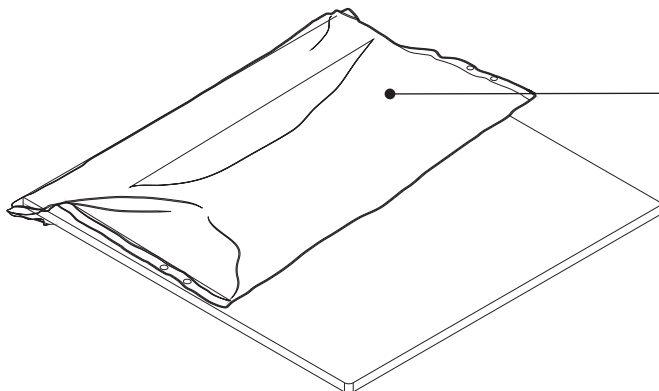

13.10.01.167 x 1

13.10.01.179 x 1

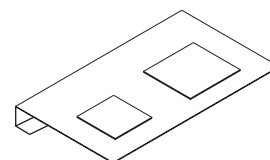

13.10.01.174 x 1

3 / 2

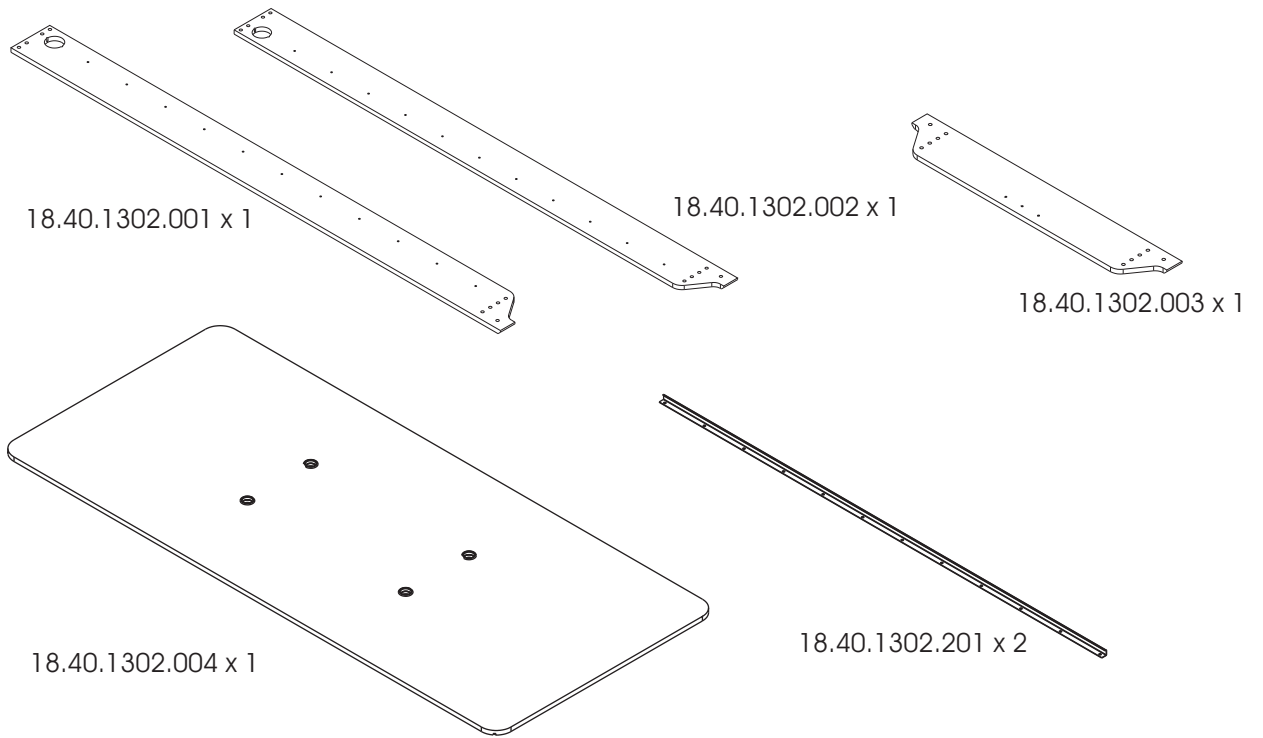

3 / 3

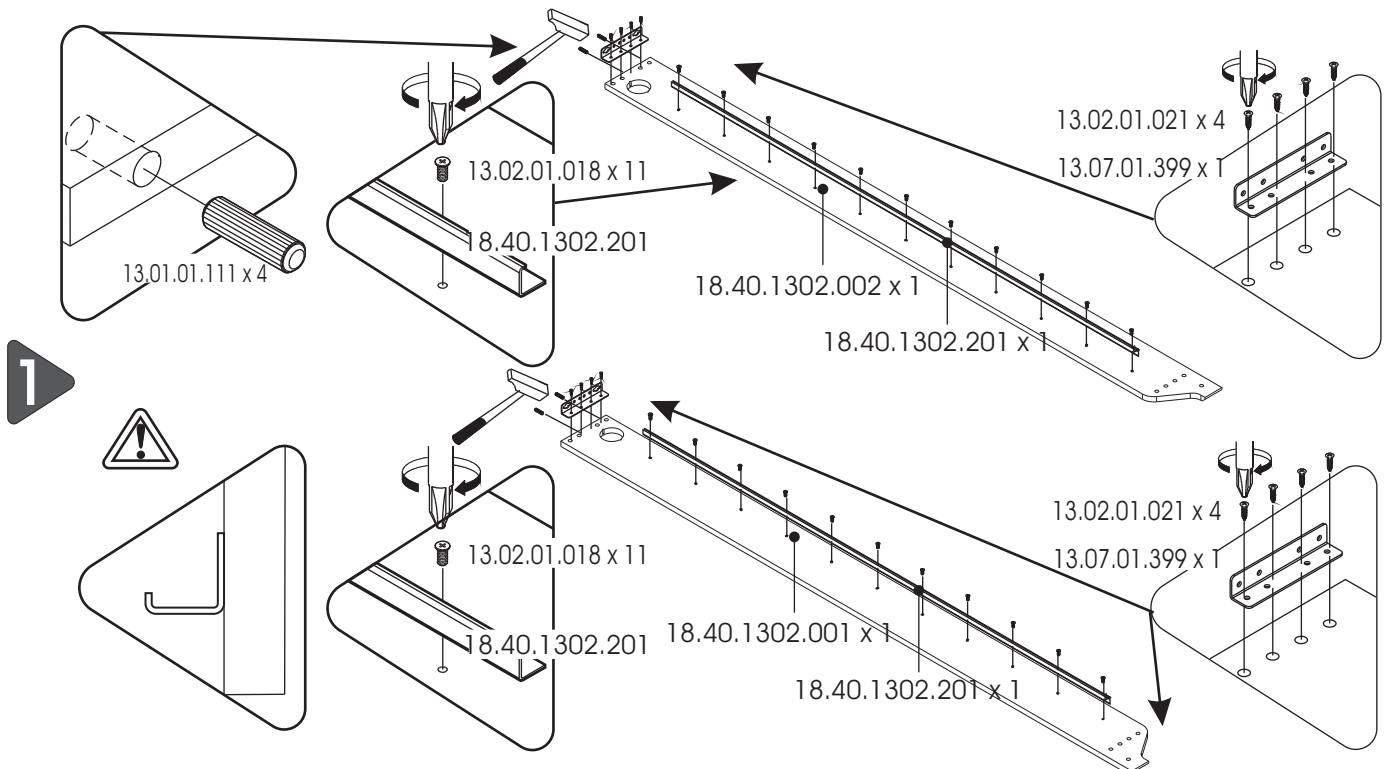
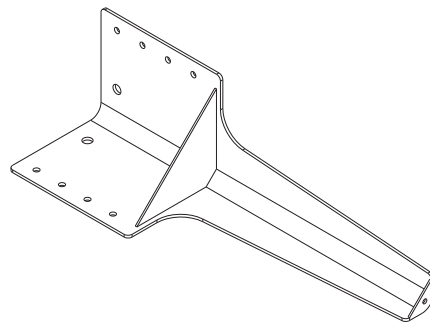

2

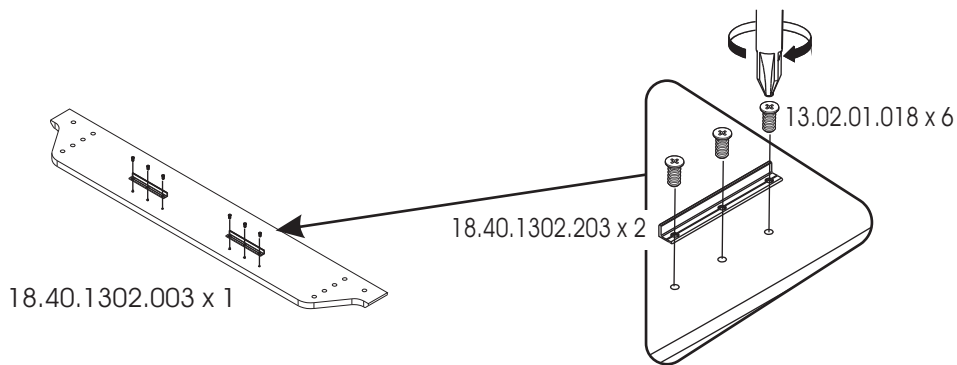

3

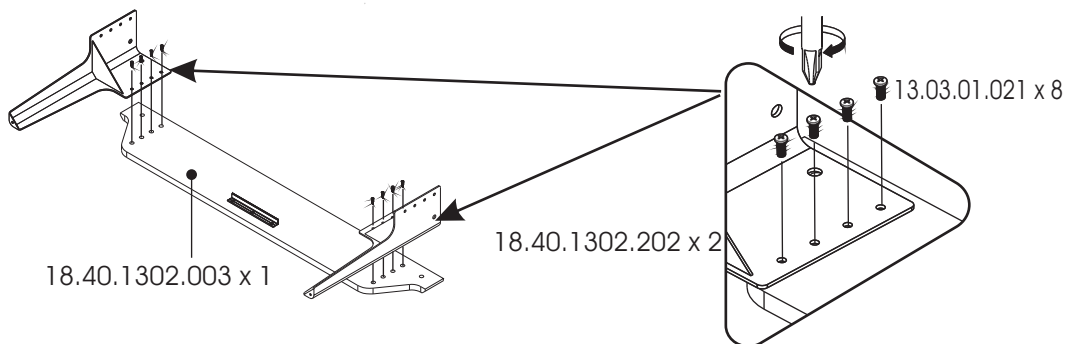

4

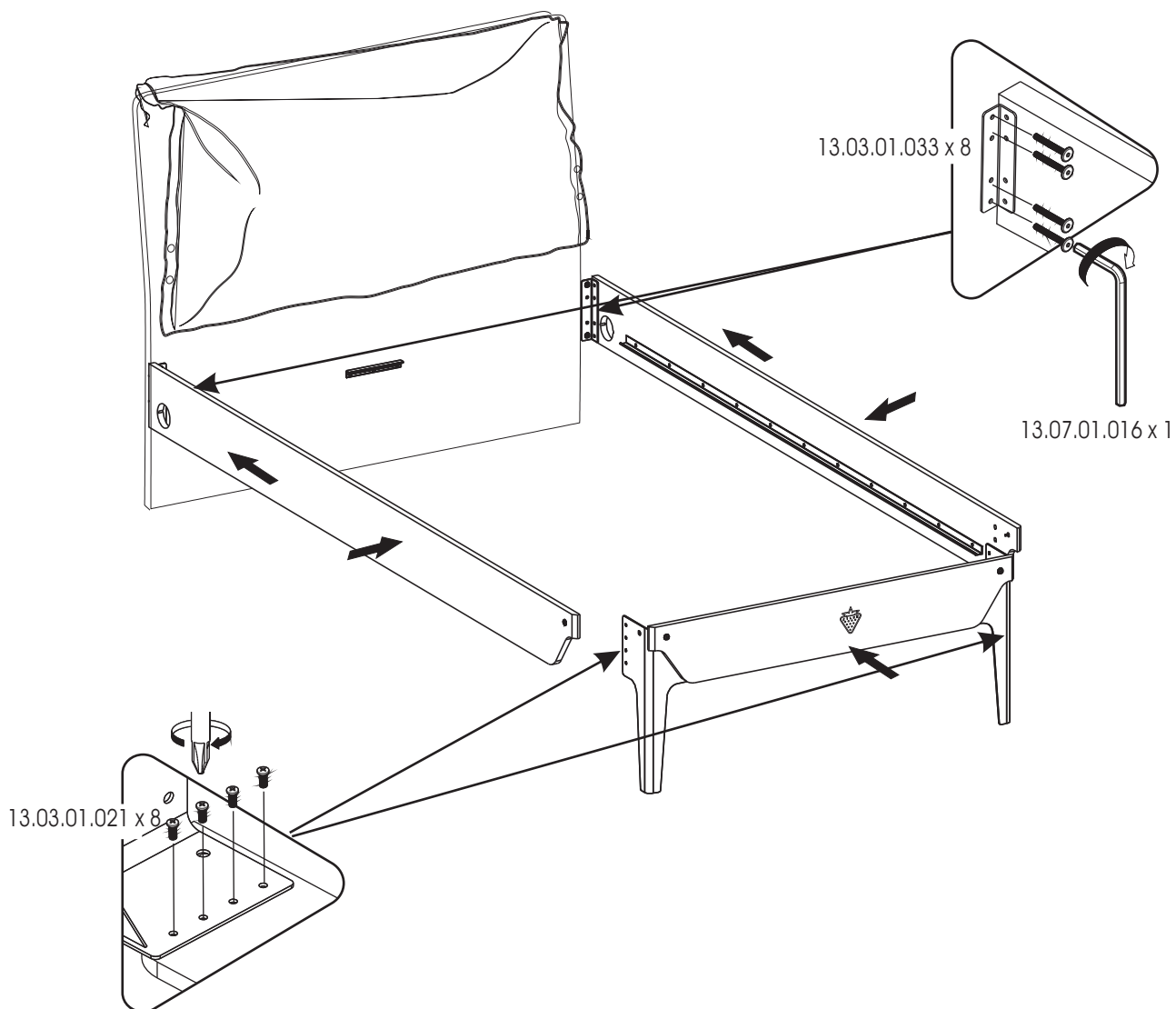

5

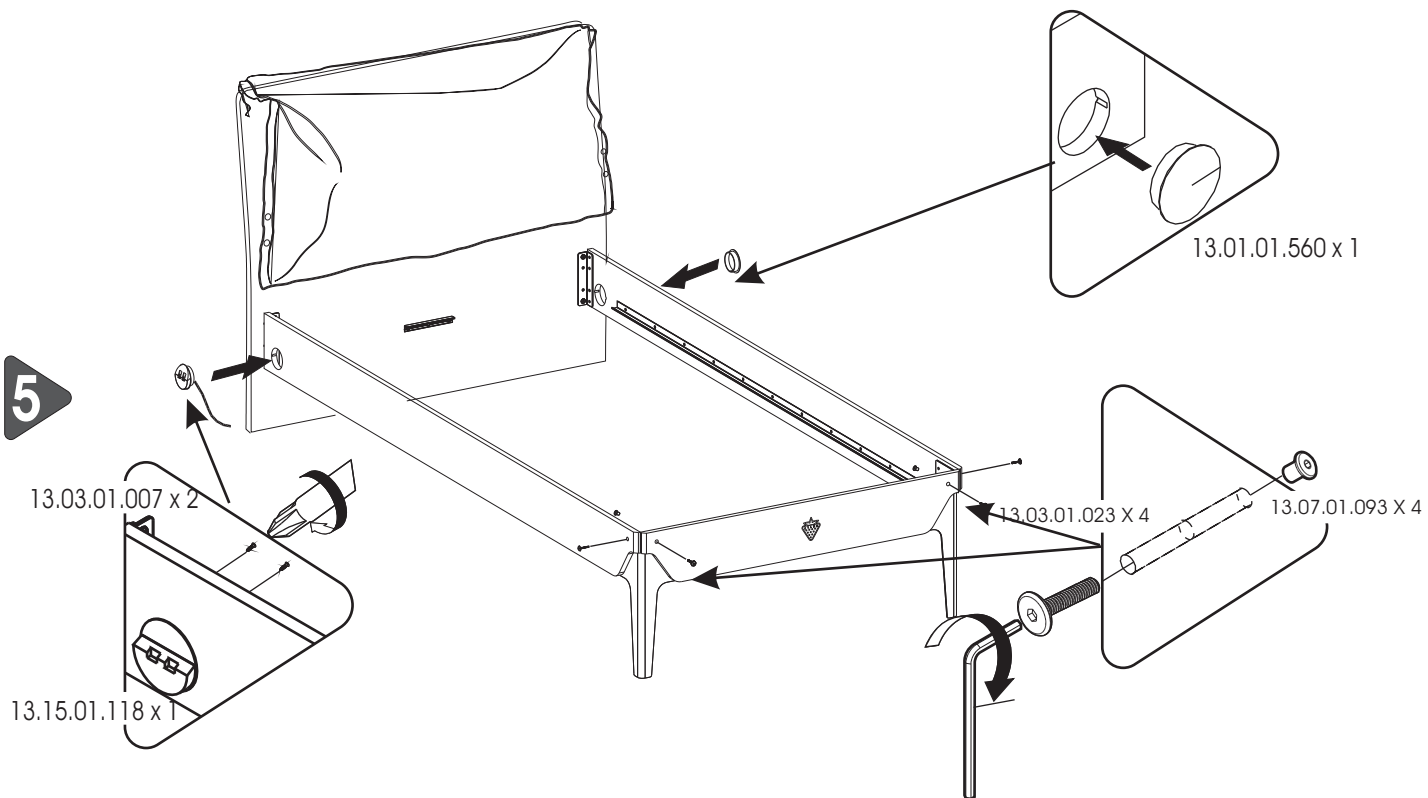

6

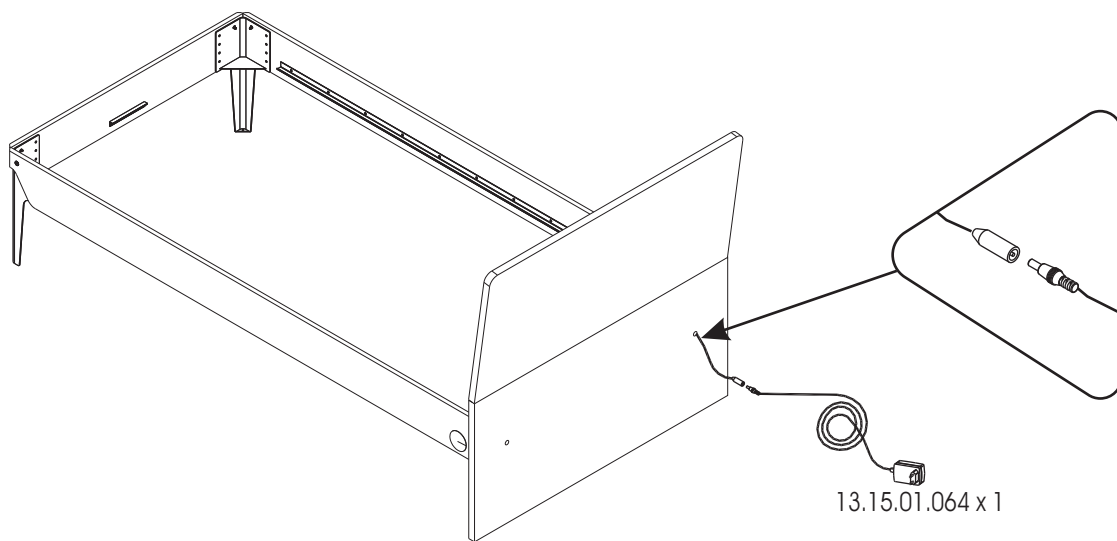

7

