

20.55.1302.00

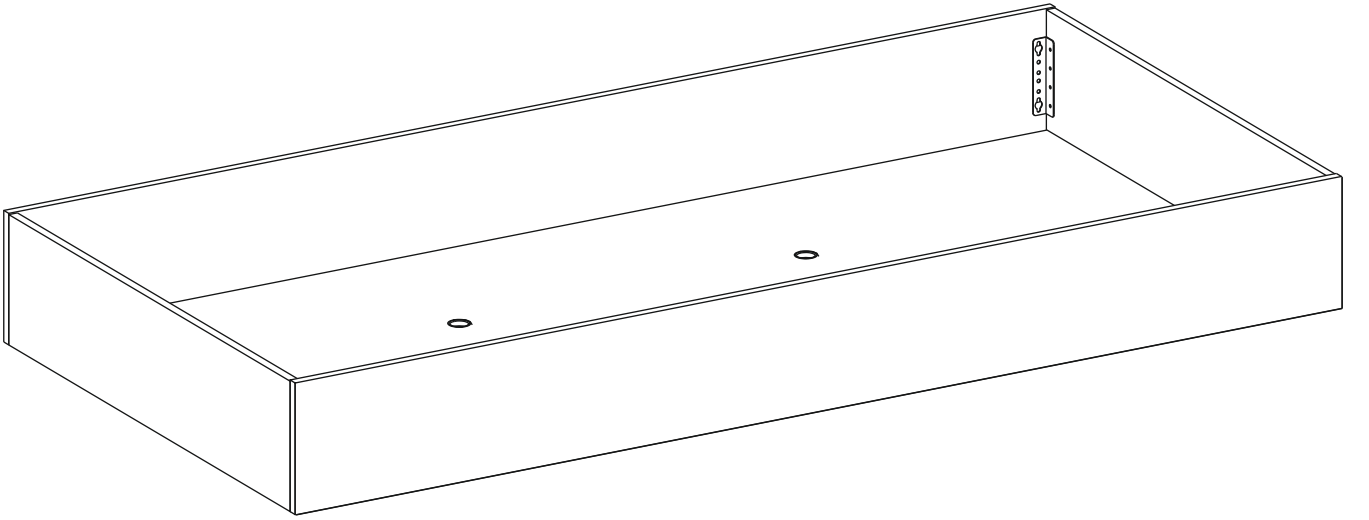

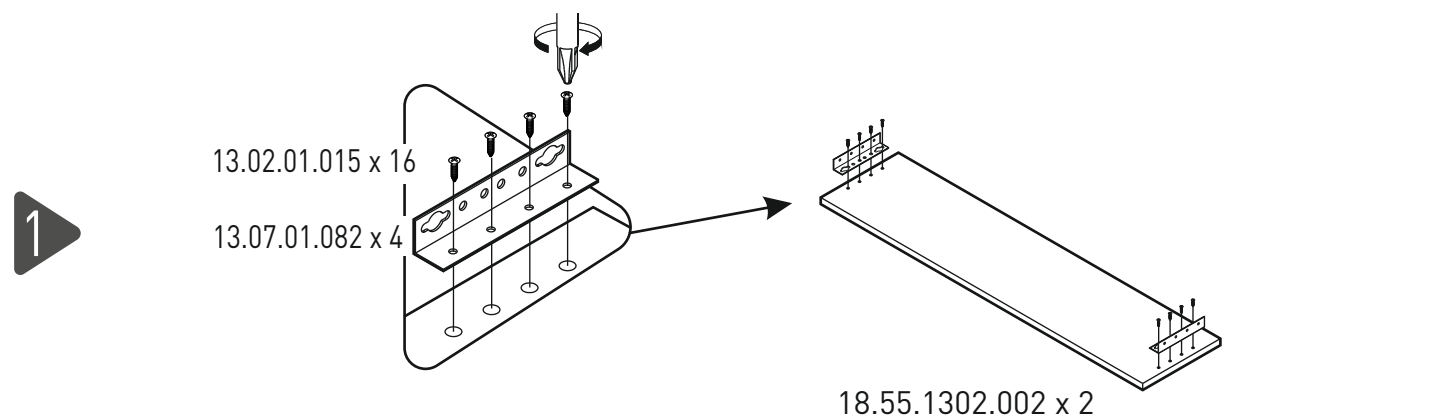

2

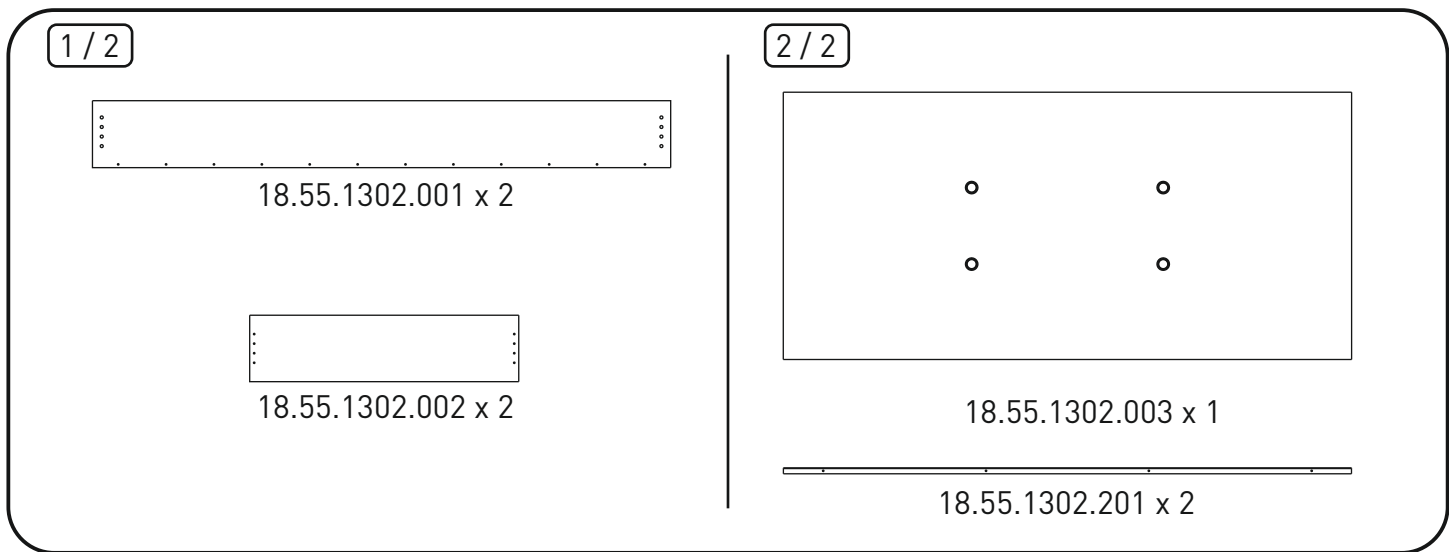
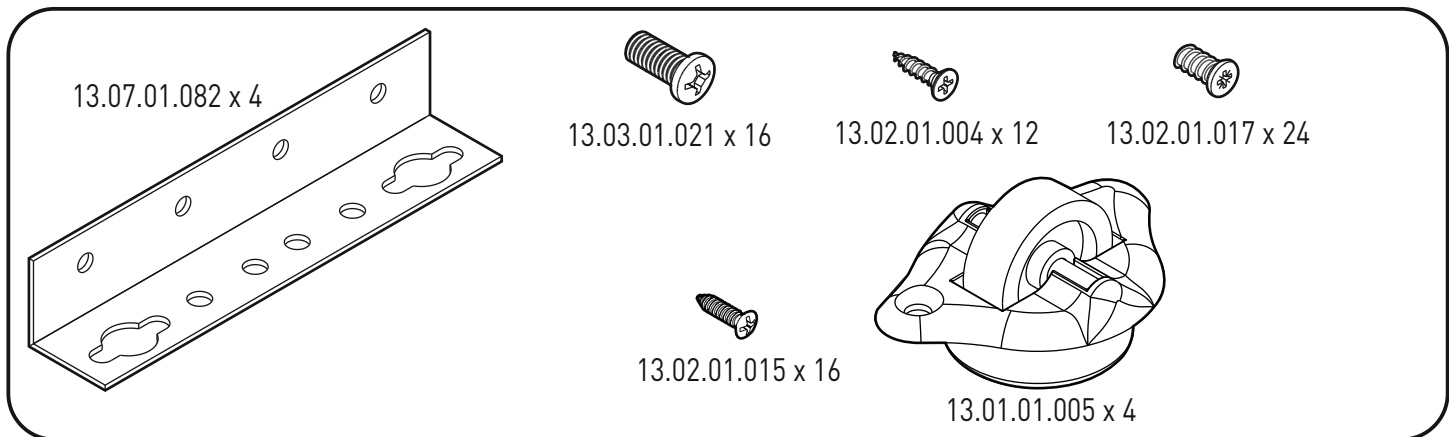
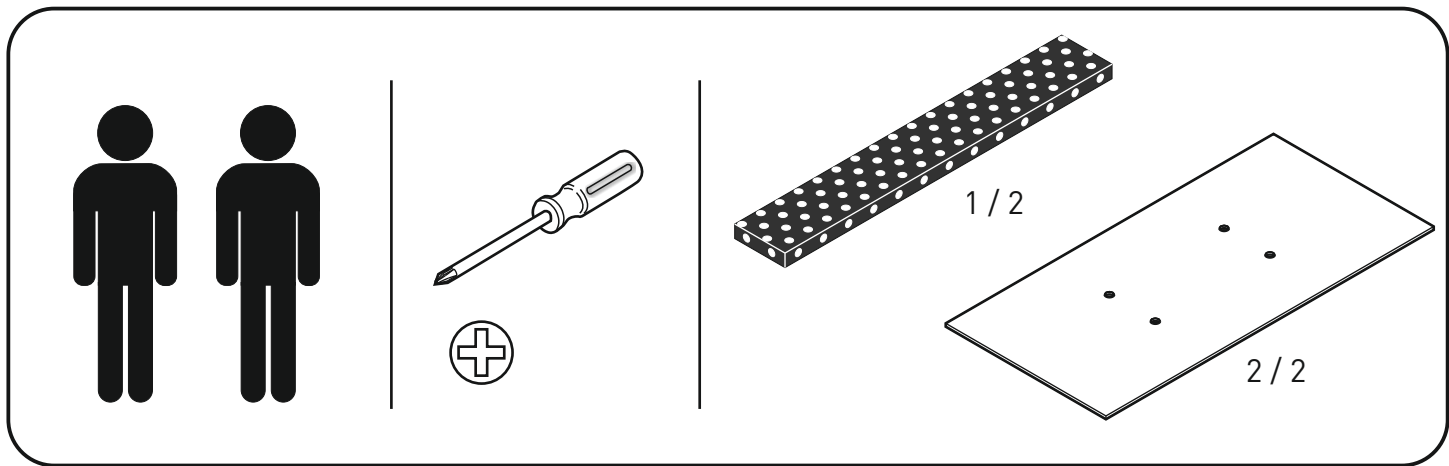
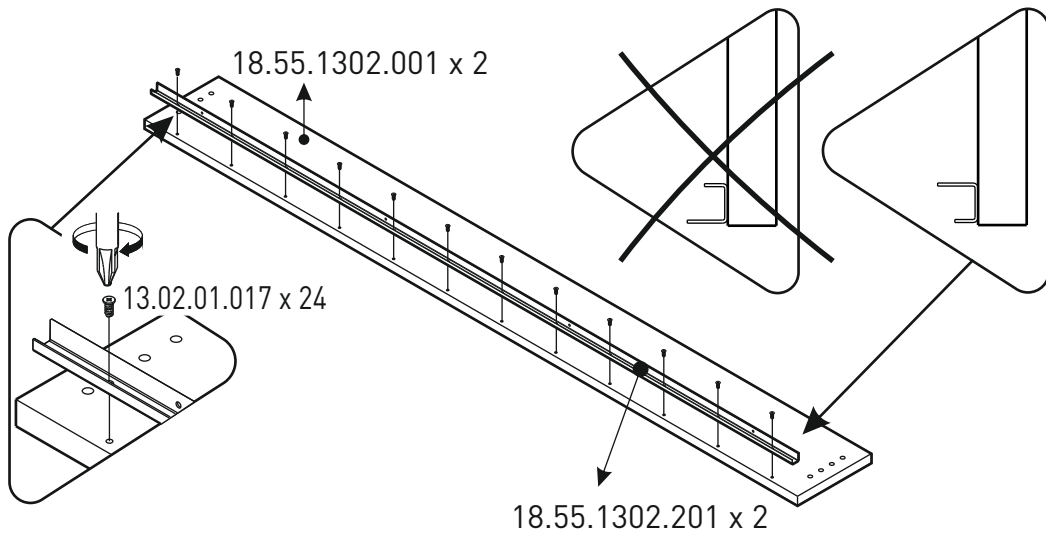

3

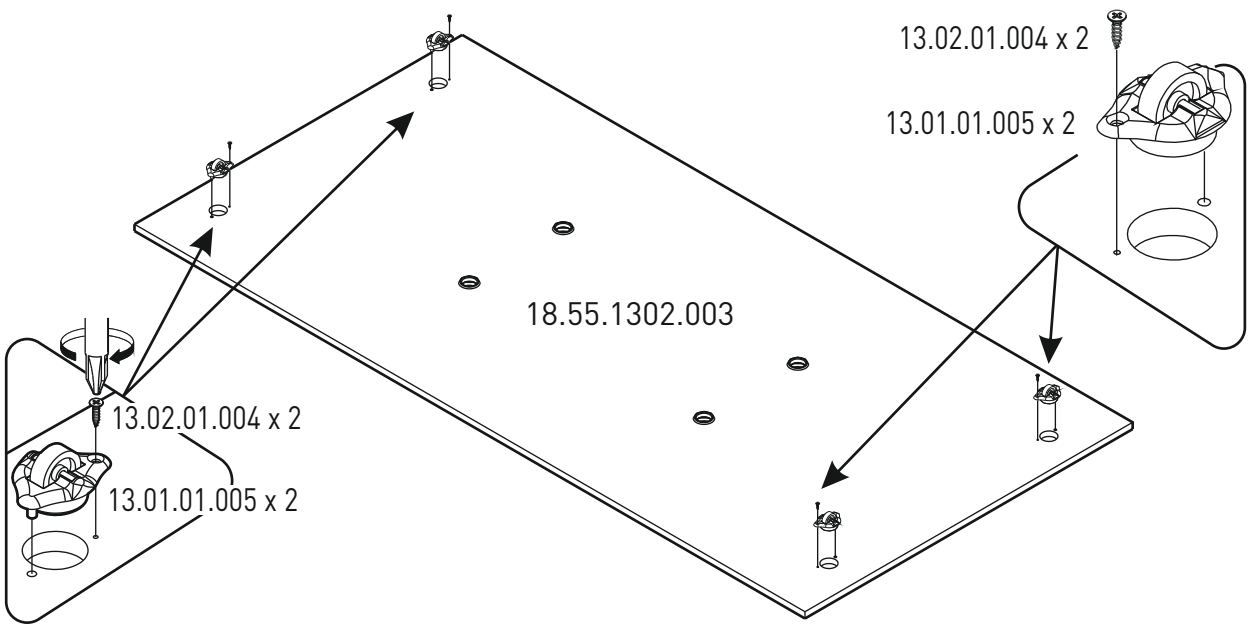

4

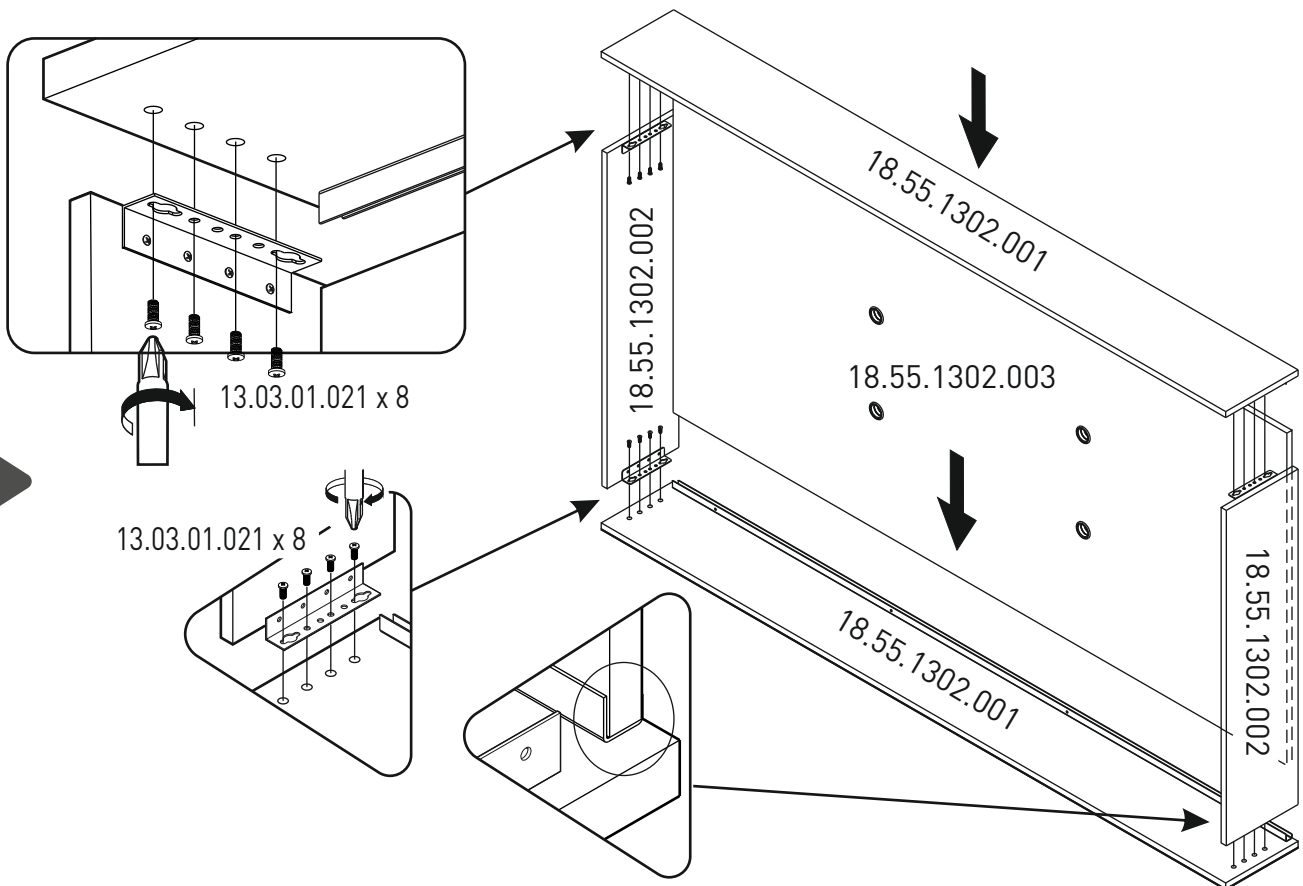

5

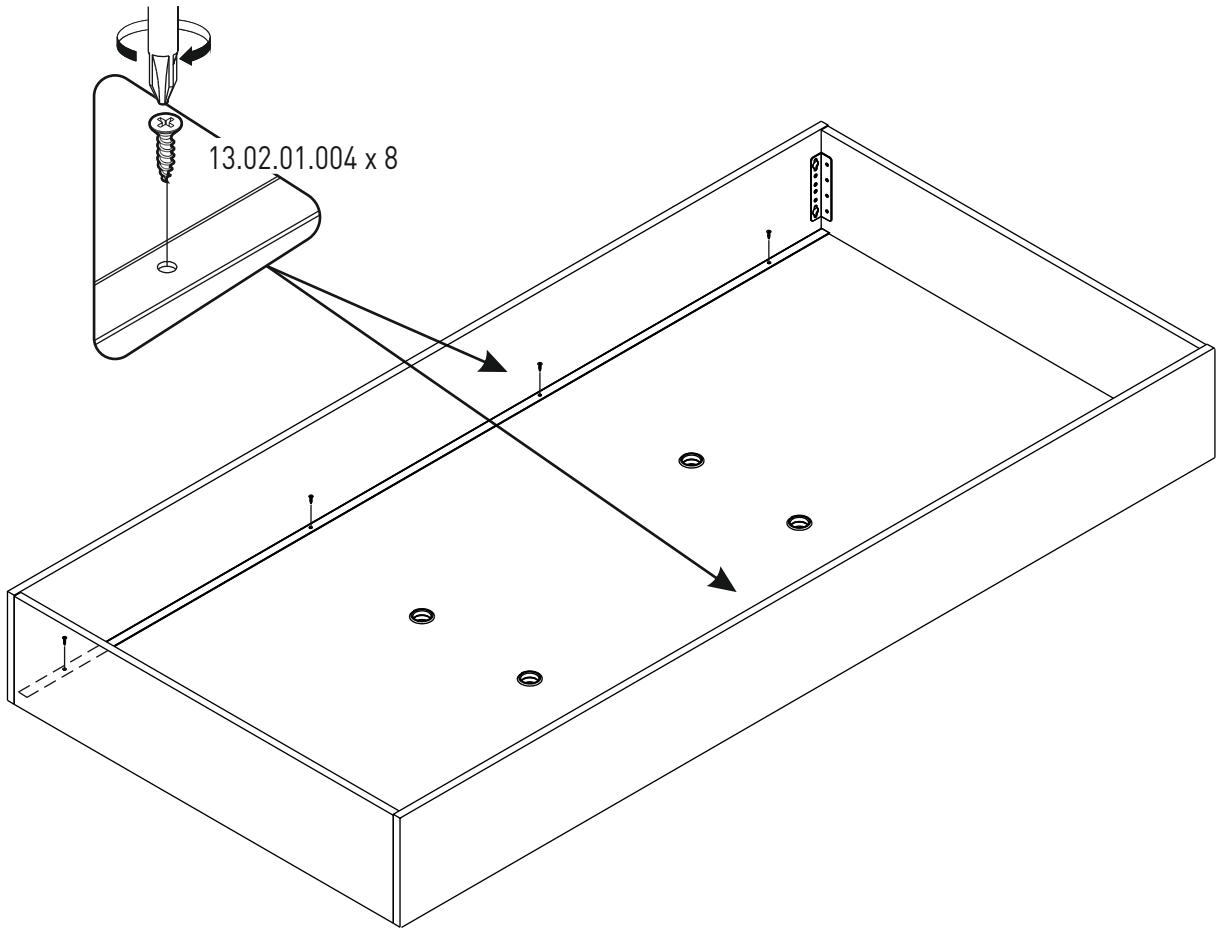

6

